

USER'S GUIDE

FOLDING AND INSERTING MACHINE

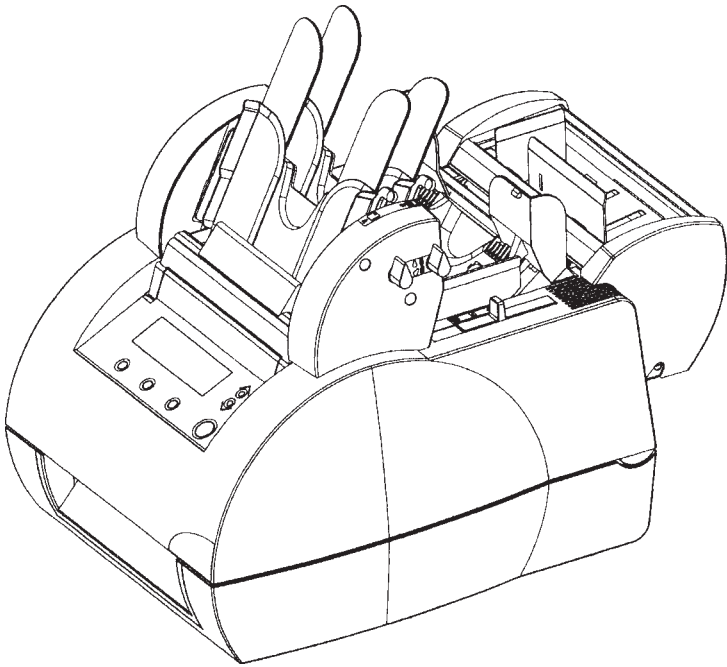

INTRODUCTION

Your folding and inserting machine enables you to fold documents, insert them into envelopes and seal the envelope flaps. Small format documents can be added to folded large format documents, or can be inserted individually, without folding.

This user-friendly machine operates automatically and efficiently. It makes short work of dispatching invoices, mass mailings, payrolls, daily mail, etc.

The information contained in this guide will help you to get the best use and productivity from your machine.

Its main features are:

- Two automatic feeder trays for large format documents (mainly A4 or US letter size)
- An automatic feeder tray for small format documents (small inserts or reply envelopes that are smaller in size than the outer envelope).
- The option of inserting material into envelopes of different size, including C6/5, C5, #10, with or without windows.
- Easy vertical loading of the trays
- User-friendly, intuitive interface with memory enabling each user to record and save details of the most frequent jobs.
- Automatic adjustment of the size of the folds.
- Automatic doubles detector fitted to all trays, to ensure the security of the contents of the envelope.
- Small footprint enabling the machine to fit neatly into any office environment.

OFFICIAL STANDARDS

In order to comply with standards EN60950 and UL1950, this equipment must be connected to standard installation of the construction industry. In order to protect the internal wiring, dual-pole protection against 5A current surges is required. This equipment complies with norm 55022, Class A.

INSTALLATION

This equipment must be installed close to a grounded electrical AC outlet, and the plug must be protected with a 16A fuse.

ATTENTION

UNDER NO CIRCUMSTANCES SHOULD AN ATTEMPT BE MADE TO REMOVE THE COVERS OF THE MACHINE SINCE THEY PROTECT LIVE ELECTRICAL PARTS.



WARNING: moving parts. Keep fingers, jewelry or loose clothing away.

This manual cannot be reproduced, registered or transmitted by any electronic, mechanical or other means, partly or wholly, without permission of your seller.

TABLE OF CONTENTS

SECTION A: GENERAL PRESENTATION 7

- 1. MACHINE 9**
- 2. CONTROL PANEL 10**
- 3. OPENING THE MACHINE AND INTERNAL VIEW 11**

SECTION B: FUNCTIONS 13

- 1. INSTALLATION AND START-UP 15**
 - 1.1 Installing the machine 15
 - 1.2 Installation and initial start-up 17
 - 1.3 Entering the unlocking code 17
 - 1.4 Selecting the language 18
 - 1.5 Filling the moistening tray 19
 - 1.6 Double document detection tray C 20
- 2. USING THE MACHINE 21**
 - 2.1 User Mode 21
 - 2.1.1 Stored job selection 22
 - 2.1.2 Table of stored jobs 22
 - 2.1.3 Starting a job 24
 - 2.1.4 Modifying a job 24
 - 2.1.5 Locking and unlocking a job 28
 - 2.1.6 Counter 29
 - 2.2 Advanced Functions 30
 - 2.2.1 Changing the language 31
 - 2.2.2 Settings for envelope formats and special documents 31
 - 2.2.3 Double document detection activation/
deactivation (Tray C) 36
 - 2.3 Other Advanced functions 36

2.3.1	Double document detection activation/ deactivation for trays A and B.	36
2.3.2	Displaying Job Adjustments	37
3.	LOADING DOCUMENTS	38
3.1	Loading documents (trays A and B in automatic mode)	38
3.2	Loading documents in manual mode (tray A)	40
3.3	Loading envelopes	41
3.4	Loading small inserts and reply envelopes (tray C) .	43

SECTION C: HELP AND ADVICE 45

1.	HELP GUIDE	47
1.1	Error messages	47
1.2	Symptoms and remedies	53
2.	JAM CLEARING	58
2.1	Clearing the feeders (tray A and B)	58
2.2	Unjamming the document path	59
2.3	Unblocking path of small inserts (tray C)	59
2.4	Clearing the envelope tray	60
3.	CLEANING	61
3.1	Cleaning the rollers	61
3.1.1	Internal rollers	62
3.1.2	Envelope Tray Rollers	63
3.1.3	Tray C Rollers	63
3.1.4	A/B Feeder Rollers	64
3.2	Cleaning/Replacing moistening brushes	65
3.3	Cleaning the covers of the machine	65

SPECIFICATIONS 67

Symbols used

 *Indicates necessary information*

 *Indicates potential problem area*

 *Indicates an idea or interesting point*

 *Illustration through an example*

SECTION A: GENERAL PRESENTATION

1. MACHINE	9
2. CONTROL PANEL	10
3. OPENING THE MACHINE AND INTERNAL VIEW	11

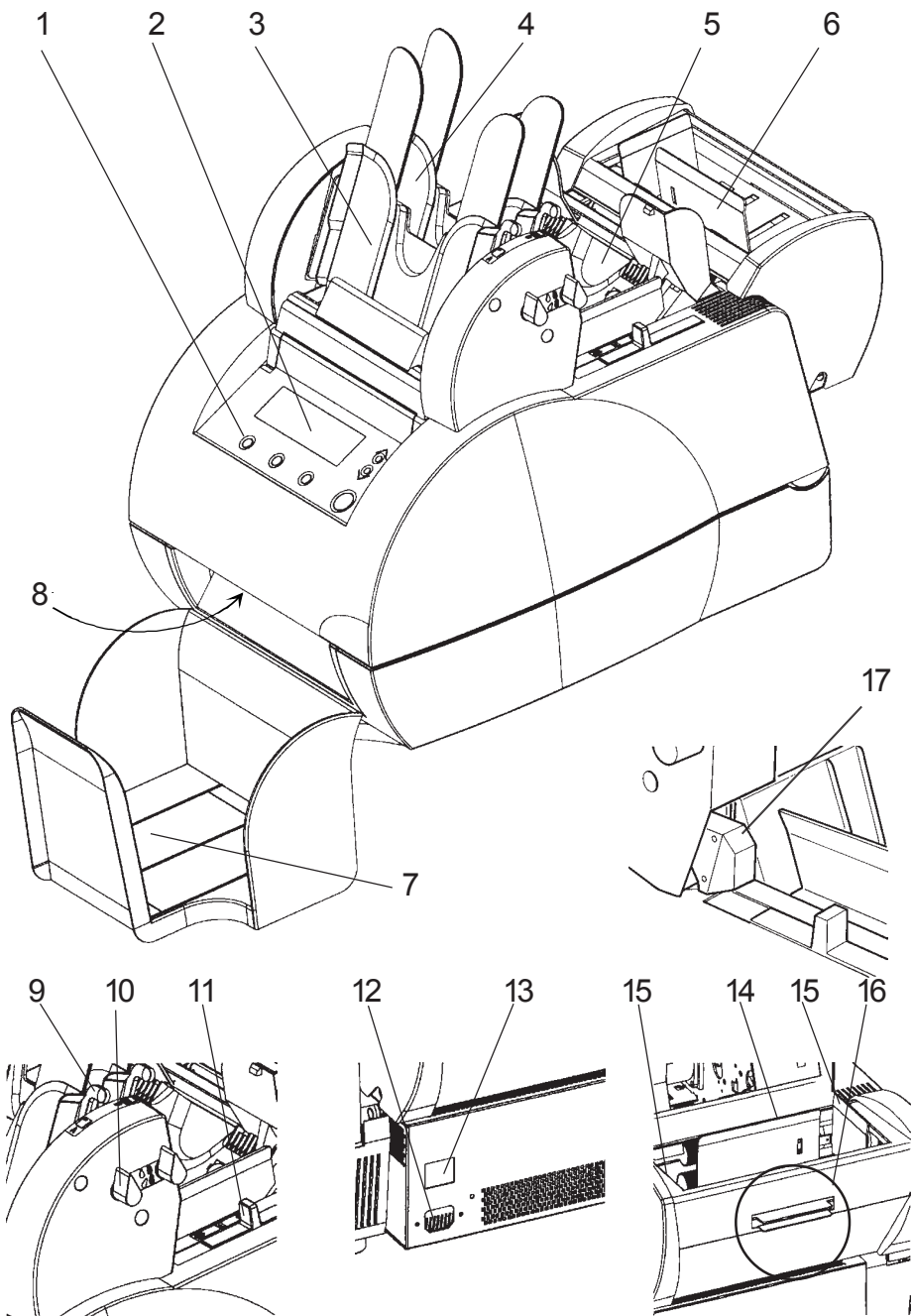

8 General presentation

1. MACHINE

- 1 Control panel
- 2 Display
- 3 Tray A (document feeder)
- 4 Tray B (document feeder)
- 5 Envelope tray
- 6 Tray C (small insert or reply envelope feeder)
- 7 Catch tray
- 8 Opening handle of the machine
- 9 Paper side guide locking levers
- 10 Locking levers for trays A and B
- 11 Locking mechanism for envelope guides
- 12 Power supply socket
- 13 On/off switch
- 14 Tray C guides (small inserts)
- 15 Lateral guides
- 16 Tray C Opening handle (small inserts)
- 17 Connector for document feeders

2. CONTROL PANEL

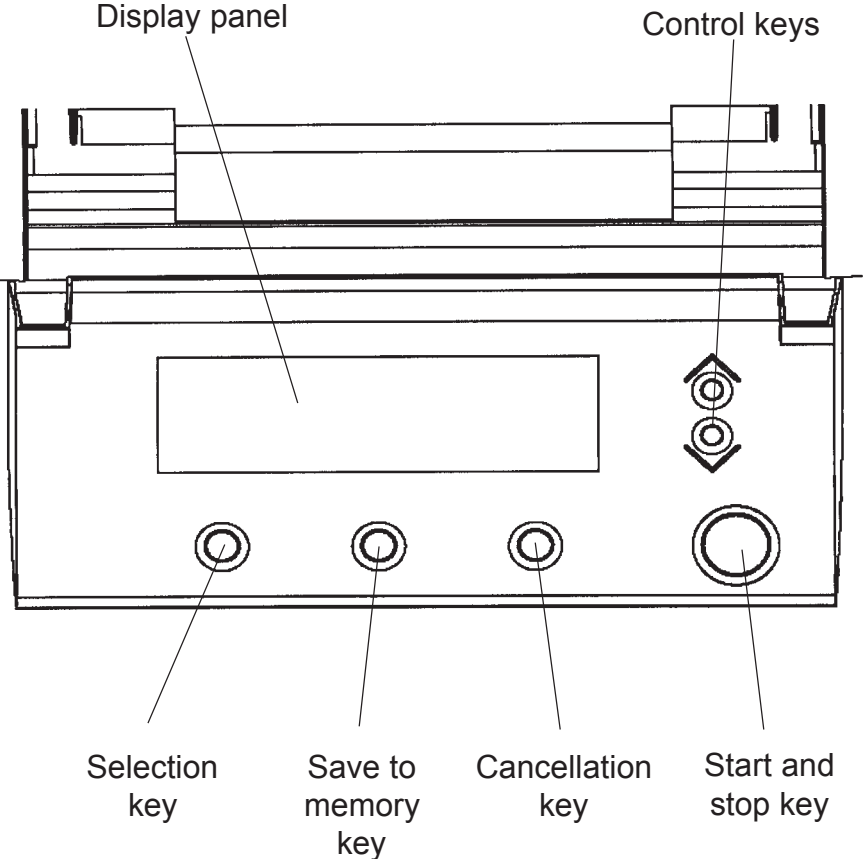

3. OPENING THE MACHINE AND INTERNAL VIEW

Opening the machine

- Squeeze the handle on the front

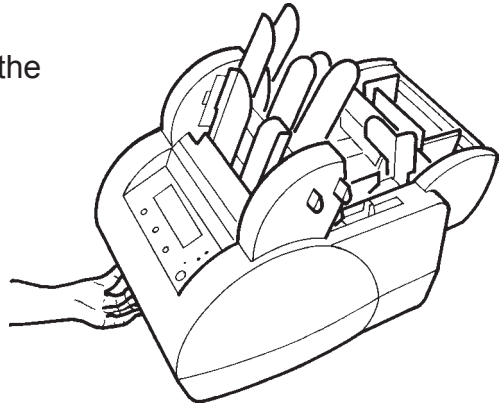

- Lift the lid of the machine upwards

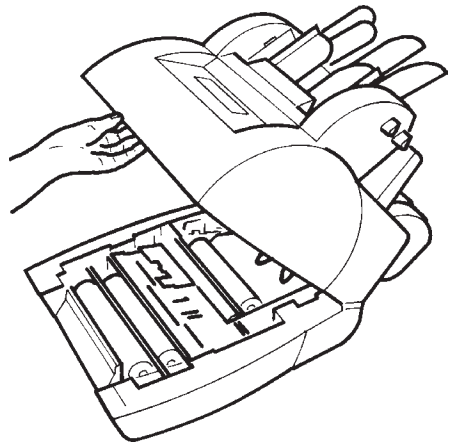

Internal view of the machine

Opening handle of
the machine

Envelope exit roller (E)

Shutter (7)

Moistening tray

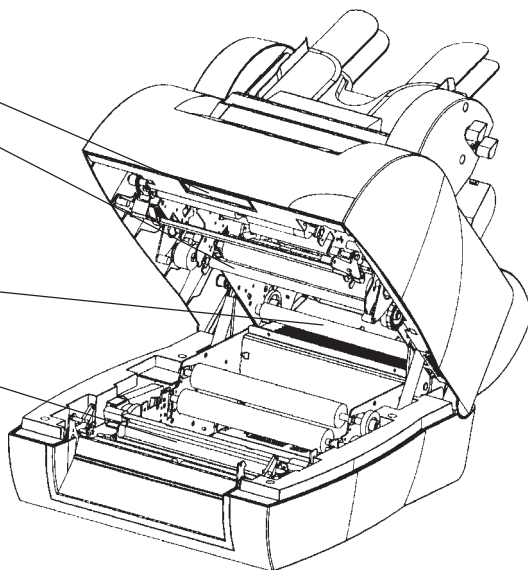

SECTION B: FUNCTIONS

1. INSTALLATION AND START-UP	15
1.1 Installing the machine	15
1.2 Installation and initial start-up	17
1.3 Entering the unlocking code	17
1.4 Selecting the language	18
1.5 Filling the moistening tray	19
1.6 Double detection tray C	20
2. USING THE MACHINE	21
2.1 User Mode	21
2.1.1 Stored job selection	22
2.1.2 Table of stored jobs	22
2.1.3 Starting a job	24
2.1.4 Modifying a job	24
2.1.5 Locking and unlocking a job	28
2.1.6 Counter	29
2.2 Advanced Functions	30
2.2.1 Changing the language	31
2.2.2 Settings for envelope formats and special documents	31
2.2.3 Double document detection activation/deactivation (Tray C)	36
2.3 Other Advanced functions	36
2.3.1 Double document detection activation/deactivation for trays A and B.	36
2.3.2 Displaying Job Adjustments	37
3. LOADING DOCUMENTS	38
3.1 Loading documents (trays A and B in automatic mode)	38
3.2 Loading documents in manual mode (tray A)	40
3.3 Loading envelopes	41
3.4 Loading small inserts and reply envelopes (tray C)	43

1. INSTALLATION AND START-UP

1.1 Installing the machine

Upon receiving the machine, check the content according to the list below :

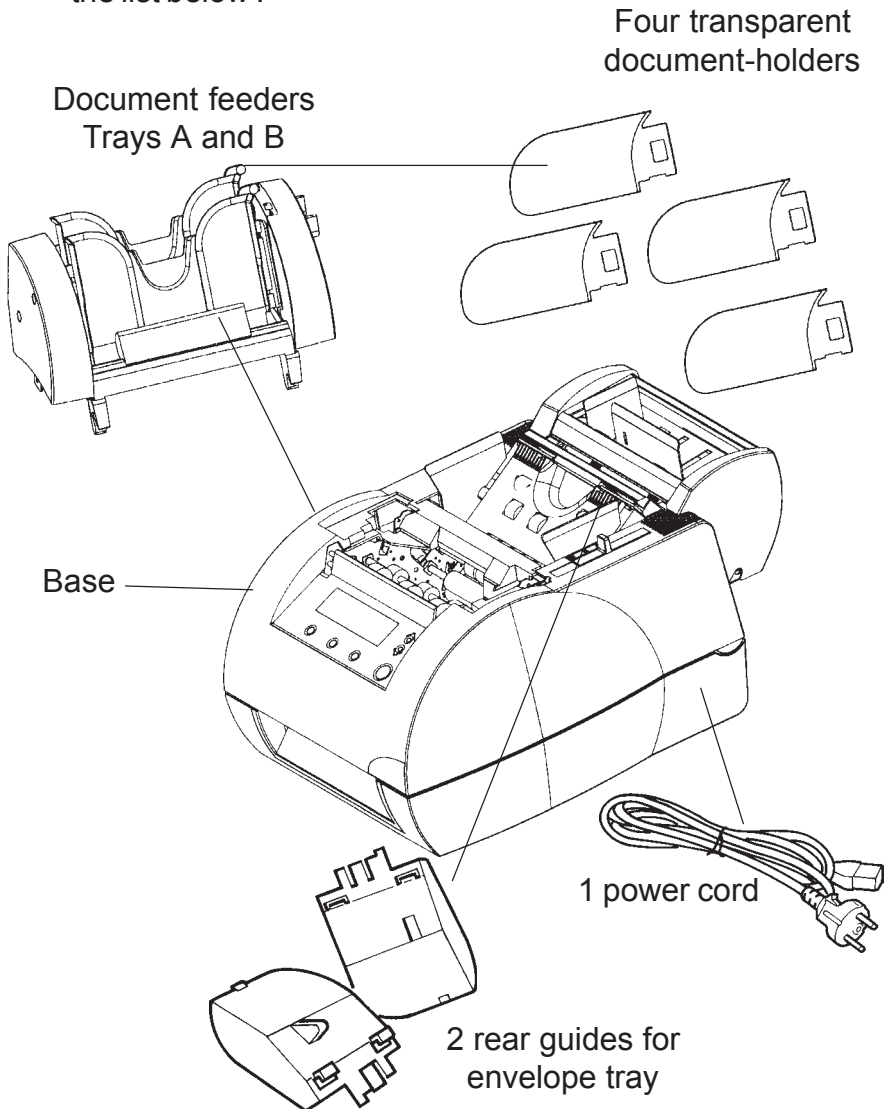

1. Install the document feeder by inserting its 2 plastic lugs into their respective slit, located on the base of the machine.

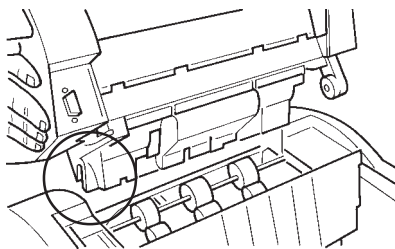

2. Hold the feeder towards you, plug the connector to the A/B feeder socket, then replace the feeder properly on the base.

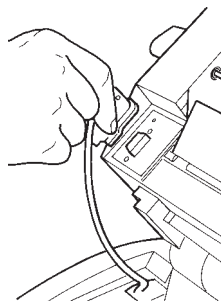

3. Clip the guides onto the back of envelope tray : be careful regarding the position

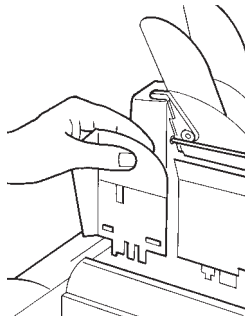

4. Clip-on the transparent document holders on trays A and B.

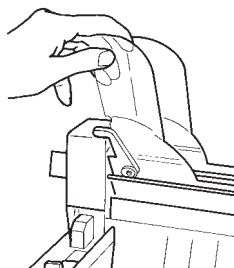

Connect the power cord to the machine and press the switch: the initialization screen will be displayed for a few seconds.

1.2 Installation and initial start-up

When the machine is powered up, the initialization screen will be displayed for a few seconds. The number displayed is the total number of cycles the machine has performed, all tasks included.

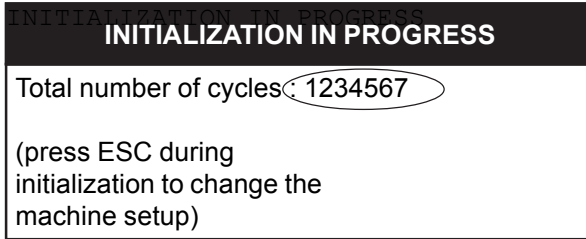



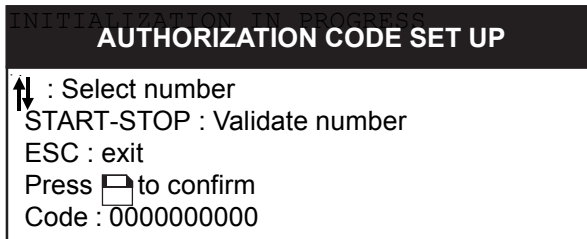

1.3 Inputting the unlocking code

This screen will automatically appear at the final step of the installation procedure.

Input the code number appearing in section J of your quick start-up guide as follows:



1. Select a number between 0 and 9, using the keys 
2. Press  to select the number and the cursor should move automatically to the next position.
3. Repeat these two operations until you have finished inputting (10 digits).
4. If you make a mistake when inputting your code, press  to delete and start again from the beginning.

5. Once your code is input correctly, press  to store it.





1.4 Selecting the language

The default configuration of your machine is English.

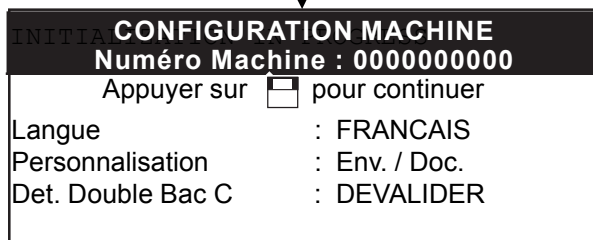
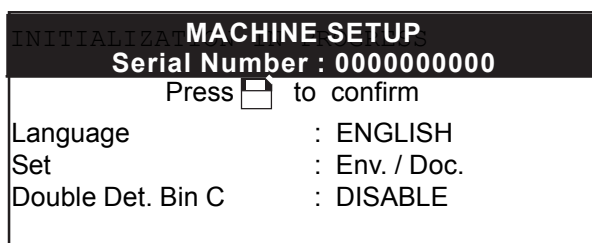
To modify the language:

- If the machine is switched on, switch it off then on again.
- During the initialization phase press  to enter the following window:



- Upon entering this screen, the "language" line indicates the language used.
- Select this line by pressing the  key.
- Scroll until you have reached the desired language and select it using the  keys.
- Complete the operation by saving the changes with .
- Or by cancelling the changes with .

1.5 Filling the moistening tray

The moistening tray is a device that enables the machine to moisten the glue on the envelope flap so that it can be sealed. This screen appears each time the machine is started up and remains active for several seconds.

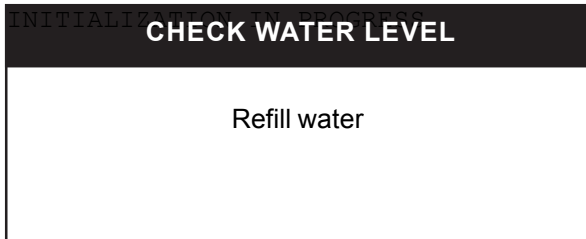

Do not do this if you have already done

To fill the moistening tray:

1. Open the machine

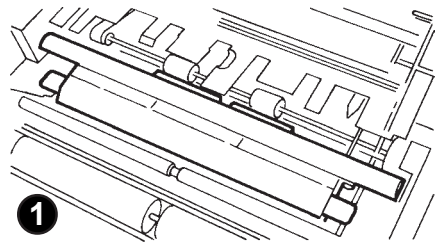

2. Remove carefully the moistening tray by its blue handles.

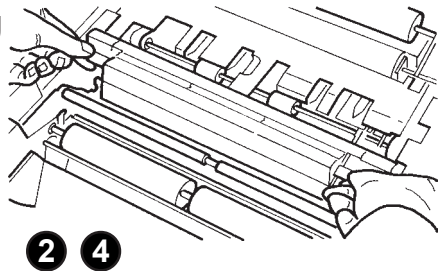

3. Remove the strip of 3 stoppers and fill the tank with water through the 3 holes. Ensure the brushes are properly impregnated with water.

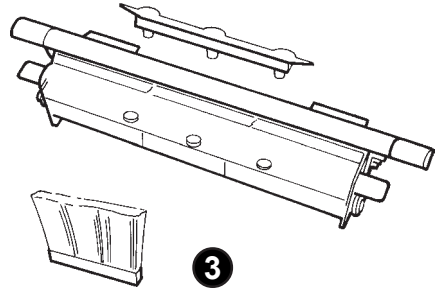

4. Replace the moistening tray in the machine, with the blue handles towards you.

5. Close the machine

1.6 Double detection tray C

This option is deactivated by default.

This function enables the machine to detect the presence of two small inserts passing simultaneously through the insertion circuit.

To activate it, select this function, using .

and validate it using the  key.

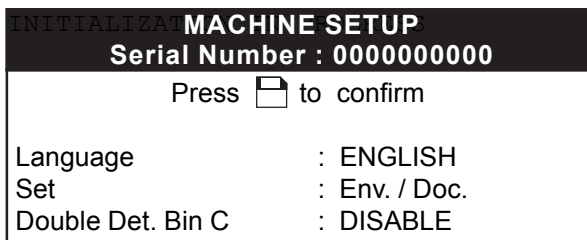

1. Select the language
2. Set the sizes for specific documents (envelopes or paper)
3. Validate or unvalidate the Tray C double detection.

2. USING THE MACHINE

To use the machine, the following must be specified:

- type of document
- type of envelope
- trays

This information is saved by the machine as a "job", corresponding to a specific application. There are nine (9) jobs which can be stored in memory for later recall.

Fill the tray or trays concerned, depending on the task to be performed (see section entitled "loading documents").

2.1 User Mode

When the user menu appears, the machine is ready for use.

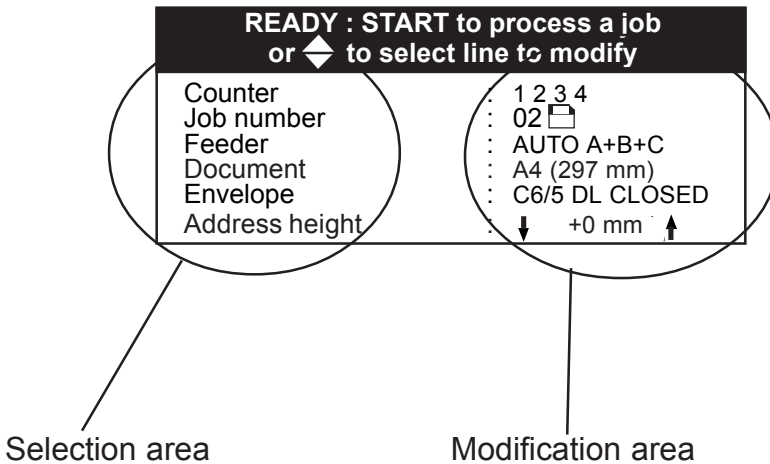





2.1.1 Stored job selection

When first entering this screen, no line is active.

Pressing the  key activates the "Counter" line, and each time this key is pressed, the next line will be selected.

Use the  keys to select the job number desired
(The machine is delivered with 9 pre-stored jobs).

READY : START to process a job or  to select line to modify	
Counter	: 1 2 3 4
Job number	: 02 
Feeder	: AUTO A+B+C
Document	: A4 (297 mm)
Envelope	: C6/5 DL CLOSED
Address height	:  +0 mm 

2.1.2 Table of stored jobs



In the pre-stored jobs, the default document format is A4 (210x297mm). The machine defines automatically the folding parameters to fit the size of the envelope chosen.



A pre-stored job will certainly suit your needs. If not, please consult the section entitled "Modifying a job".

Job number	Trays	Envelopes	Functions
Job 1	AUTO A+B	C6/5-DL SEAL	The 2 trays function together
Job 2	AUTO A+B+C	C6/5-DL SEAL	The 3 trays function together

Job 3	AUTO A	C6/5-DL SEAL	Trays A and B function alternately, when one tray is empty, the machine switches automatically to the other
Job 4	AUTO A+C	C6/5-DL SEAL	Trays A and B function alternately, and tray C functions simultaneously with whichever tray is operational.
Job 5	AUTO A+B+C	C5 SEAL	The three trays, A, B and C operate together
Job 6	AUTO A+C	C5 SEAL	Trays A and B function alternately, and tray C functions simultaneously with whichever tray is operational.
Job 7	MANUAL A	C6/5-DL SEAL	Tray A functions alone in manual AutoStart mode. Documents are inserted manually in tray A.
Job 8	MANUAL A	C5 SEAL	Tray A functions alone in manual AutoStart mode. Documents are inserted manually in tray A.
Job 9	MANUAL A+C	C5 SEAL	Tray A functions alone in manual AutoStart mode and tray C is on Automatic. One document from tray C is added to the bundle in tray A.



Envelope C6/5 :





~ 114 mm

Envelope C5:



~ 162 mm

2.1.3 Starting a job

- Select the line "Job number", with the  key.
- Choose a job number with .
- Load the appropriate trays with your documents.
- Press the  key to start the cycle.



The cycle can be interrupted at any time by pressing the  key again.





- *An on-line help message is displayed on the screen for each job.*
- *If the job selected uses the "Manual" (AutoStart) function it is not necessary to press the  key. Tray A starts automatically when inserting a sheet of paper.*

2.1.4 Modifying a job

Jobs already in the memory can be modified:

- Select the line "Job number", with the  key.
- Choose the job number to be modified with .
- Make the necessary changes, including selection of trays, document format and envelope format.
- Launch the cycle by pressing the  key.



As long as the  icon is flashing, the changes have not been finalized. Press  to save them to the memory.



- *To test the settings quickly, press  twice: the machine will perform a single cycle.*

Selecting trays :





To change the tray operating mode in a job.

- Select the "Tray" line using the key .
- Select the desired function using the keys .

Tray functions available:

AUTO A+B	AUTO A+C	MANUAL A+B
AUTO A	AUTO C	MANUAL A+C
AUTO A+B+C	MANUAL A	MANUAL A+B+C

Trays A and B enable the insertion of large format documents, of the A4 type, that are to be folded. They accept documents measuring from 177 mm to 356 mm.

Press  to choose feeders or START to process a job	
Counter	: 1 2 3 4
Job number	: 02 
Feeder	: AUTO A+B+C
Document	: A4 (297 mm)
Envelope	: C6/5 DL CLOSED
Address height	:  +0 mm 

The largest document format will be taken into account for folding purposes.





- **Auto: Automatic operating mode, starts after pressing the key** .

The envelope by envelope operating mode starts with "Autostart" mode (manual insertion of a sheet of paper or bundle of up to five sheets).





Selection of document format

To change the format of the main document in a job

- Select the "Document" line using the key .
- Select the desired format using the  keys.



Document formats available

A4 (297 mm), 12" (305 mm), A5 (210 mm)
SPECIAL (see "Advanced functions")

Press  to select format or START to process a job	
Counter	: 1 2 3 4
Job number	: 02 
Feeder	: AUTO A+B+C
Document	: A4 (297 mm)
Envelope	: C6/5 DL CLOSED
Address height	:  +0 mm 





Envelope selection

To change the envelope format in a job.

- Select the "Envelope" line using the key .
- Select the desired format using the keys .

Envelope formats available

C6/5-DL	Closed	SPECIAL	Closed (see "Advanced functions")
C6/5-DL	Open	SPECIAL	Open (see "Advanced functions")
C5	Closed	FOLDING ONLY 2	
C5	Open	FOLDING ONLY 1	

Press  to select format and mode or START to process a job	
Counter	: 1 2 3 4
Job number	: 02 
Feeder	: AUTO A+B+C
Document	: A4 (297 mm)
Envelope	: C6/5 DL CLOSED
Address height	:  +0 mm 







Envelope C6/5 :  ~ 114 mm

Envelope C5:  ~ 162 mm

Changing the height of the address

This setting enables adjustment of the fold position to have the printed address seen through the envelope window.

- Select the line "Address Height" using the key .
- Change the setting using the keys .
- Perform a test run by pressing the  key twice.
- Once you have the correct setting, start the cycle by pressing the  key once.

Press to move address in ↓↑ or START to process a job	
Counter	: 1 2 3 4
Job number	: 02 
Feeder	: AUTO A+B+C
Document	: A4 (297 mm)
Envelope	: C6/5 DL CLOSED
Address height	: ↓ +0 mm ↑

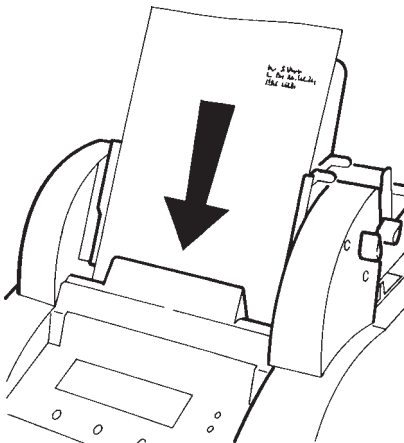

Place the document in tray A, face up, with the address at the top right.

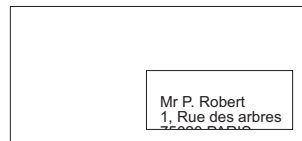

The  key moves it upwards in the window

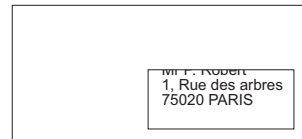



The  key moves it downwards in the window

2.1.5 Locking and unlocking a job



To protect a job, no line should be selected.

If so press  to deselect.



To lock a job:



- Complete any changes to the settings using the key ,
- Keep this key pressed,
- Save to memory using the key ,
- A key-shaped icon  will appear next to the number of the amended job.

Only the job in progress can be amended (the one with the same number).

READY : START to process a job or  to select line to modify	
Counter	: 1 2 3 4
Job number	: 02  
Feeder	: AUTO A+B+C
Document	: A4 (297 mm)
Envelope	: C6/5 DL CLOSED
Address height	: ↓ +0 mm ↑

To unlock a job:

- Press the key ,
- Keep this key pressed,
- Validate and save the unlocking using the key ,
- The job is then unprotected, and the key-shaped icon  beside the job number will disappear.



READY : START to process a job or  to select line to modify	
Counter	: 1 2 3 4
Job number	: 02 
Feeder	: AUTO A+B+C
Document	: A4 (297 mm)
Envelope	: C6/5 DL CLOSED
Address height	: ↓ +0 mm ↑





2.1.6 Counter





The machine has 2 counters.

- The first one can be read on the initialization screen when the machine is switched on. It indicates the total number of cycles performed, all jobs included, since the machine was used for the very first time. It cannot be changed.
- The second counter, which displays on the main screen, is a meter that monitors activity and it can be returned to zero. It indicates the total number of cycles performed on all jobs inclusive since it was last returned to zero.

To return a job meter to zero:

- Select the line "Counter" using the key .
- Return it to zero using the keys .

Press   to reset by zero or START to process a job	
Counter	: 1 2 3 4
Job number	: 02 
Feeder	: AUTO A+B+C
Document	: A4 (297 mm)
Envelope	: C6/5 DL CLOSED
Address height	:  +0 mm 

Press   to reset by zero or START to process a job	
Counter	: 0000
Job number	: 02 
Feeder	: AUTO A+B+C
Document	: A4 (297 mm)
Envelope	: C6/5 DL CLOSED
Address height	:  +0 mm 

2.2 Advanced Functions

To enter the advanced functions mode:



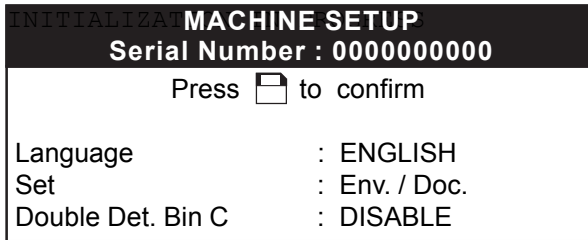

- During initialization, press the key .

The following screen will appear:



2.2.1 Changing the language

The machine's user default language is set to English. This can be changed by holding down the  key while switching the machine ON from the switch located at the back of the machine.

1. Select the «language» field using the  key,
2. Use the  keys to change the language setting,
3. Press  to store changes,
4. Press  to return to the user menu.

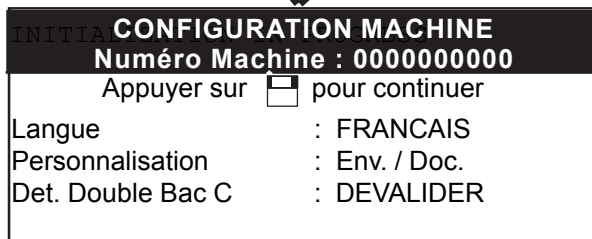
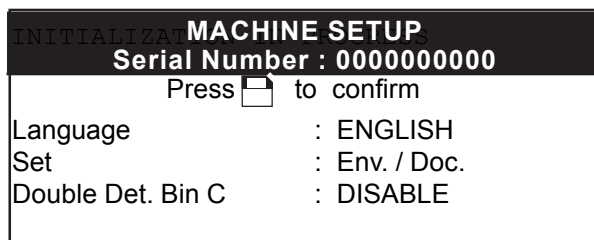

2.2.2 Settings for envelope formats and special documents



This menu allows adjustment for:

- format, size and position of the envelopes,
- position for moistening the glue on the flap,
- Special document formats.





To perform these adjustments :





INITIALIZATION MACHINE SETUP	
Serial Number : 0000000000	
Press  to confirm	
Language	: ENGLISH
Set	: Env. / Doc.
Double Det. Bin C	: ENABLE

- Select the line "SET. ENV / DOC" using the key ,
- Enter the manual adjustment menu using the key ,

SELECT THE ENVELOPE FORMAT	
Press  to confirm	
Set Standard envelope	:
Set Large envelope	:
Set Special envelope	:
Set Special document	:

- Select the line you want to change, using the key ,
- Enter the manual adjustment sub-menu using the key ,

STANDARD ENVELOPE SETUP	
Press  to confirm	
Envelope height	: 114 mm mmSet
Envelope stop position	: + 0 mm
Moistening position	: 23 mm

- Select the line to be modified, using the key ,
- Adjust the value using the keys  ,
- Store the adjustment by pressing ,
- Press  to return to previous menu.

Changing the size:

Indicate the height of the envelope or document in millimetres

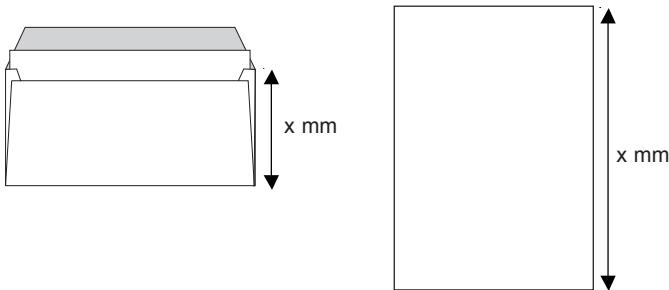

Correcting the stop position of the envelope:

You can correct the position of the envelope in order to insert folded leaflets correctly. If the settings are incorrect, the envelope may not be sealed correctly.

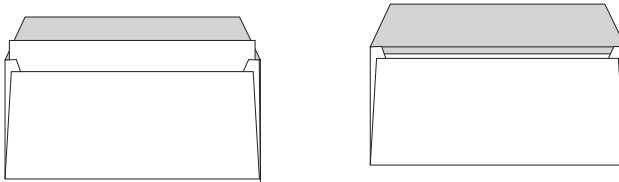

Set too high

Set too low

Correcting the moistening position:

This setting makes it possible to adjust the area to be moistened on the envelope flap. It may be necessary to adapt the moistening to the shape of the flap or the thickness of the envelope in order to ensure optimal adhesion.

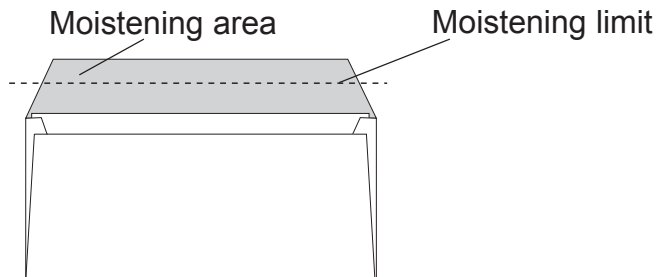



The settings indicated on the following screens are the machine's default settings.

Manual adjustment of standard envelopes

STANDARD ENVELOPE SETUP	
Press  to confirm	
Envelope height	: 114 mm <small>mmSet</small>
Envelope position	: + 0 mm
Moistening position	: 23 mm

- Size: 105 mm to 125 mm, manually adjustable
(105, 108, 110, 114, 115, 120 and 125 mm)
- Position correction: +7 mm to -8 mm, manually adjustable
(in 1 mm increments)
- Moistening position: 13 mm to 45 mm, manually adjustable
(in 1 mm increments)

Manual adjustment of large envelopes

LARGE ENVELOPE SETUP	
Press  to confirm	
Envelope height	: 162 mm <small>mmSet</small>
Envelope position	: + 0 mm
Moistening position	: 23 mm

- Size: 152 mm to 165 mm, manually adjustable
(152, 159, 162 and 165 mm)
- Position correction: +7 mm to -8 mm, manually adjustable
(in 1 mm increments)
- Moistening position: 13 mm to 45 mm, manually adjustable
(in 1 mm increments)

Manual adjustment of special envelopes

SPECIAL ENVELOPE SETUP	
Press  to confirm	
Envelope height	: 114 mm mmSet
Envelope position	: + 0 mm
Moistening position	: 23 mm

Size: 105 mm to 165 mm, manually adjustable
(in 1 mm increments)

Position correction: +7 mm to -8 mm, manually adjustable
(in 1 mm increments)

Moistening position: 13 mm to 45 mm, manually adjustable
(in 1 mm increments)





Manual adjustment of special documents

SPECIAL DOCUMENT HEIGHT SETUP	
Press  to confirm	
Size	: 297 mm

Size: 177 mm to 356 mm, manually adjustable
(in 1 mm increments)

2.2.3 Double document detection activation/deactivation (Tray C)

To activate this mode:

- Select the line "Double Det. Bin C", using .
- Activate or deactivate using the keys .
- Cancel any changes using the key .
- Save changes to memory with the key .
- Exit the mode using the key  mode.

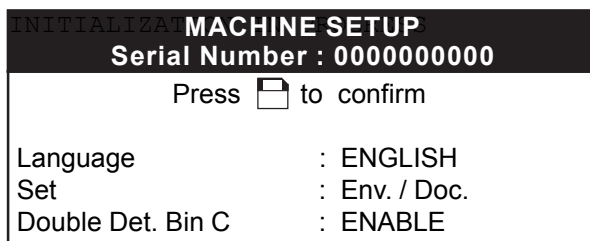

2.3 Other Advanced functions

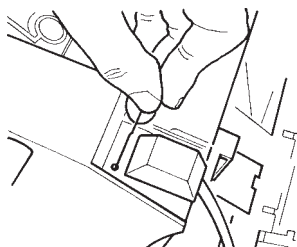

2.3.1 Double document detection activation/deactivation for trays A and B.



The double document detection is activated by default on both trays A and B. To deactivate it, use a stylus or paperclip to press a small button located near the feeder socket. A message will appear on the control panel screen.

2.3.2 Displaying Job Adjustments

To access this screen:

- You should be in user mode.
- Press the  key and keep it pressed
- Press the key 

The following screen will appear.

INFORMATION		
Press ESC to exit		
Fold A	:	095 mm
Fold B	:	103mm
Envelope height	:	114mm
Counter	:	12345

- Exit this screen using the  key to return to user mode.

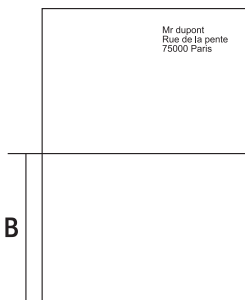

Single fold

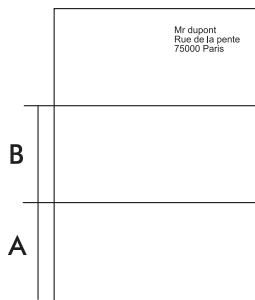

C-fold

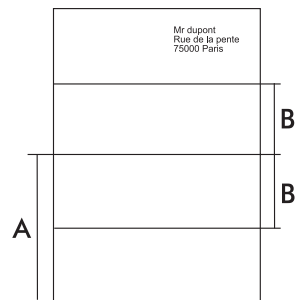

Double parallel fold

3. LOADING DOCUMENTS

3.1 Loading documents (trays A and B in automatic mode)

- ! Documents are loaded vertically in the natural direction of reading. The document containing the address must always face the user. When both feeders feed simultaneously (2 documents), the address document must be in tray A.

1. Release the blue locking levers

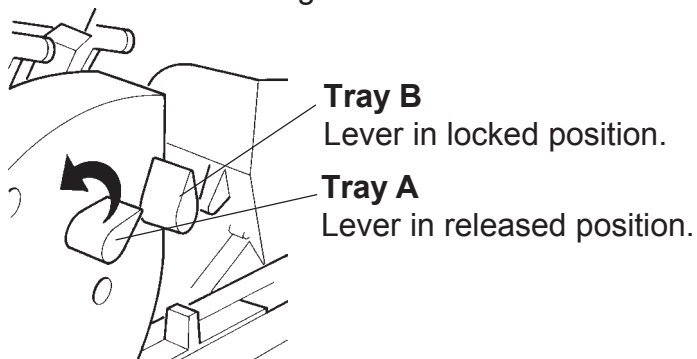

2. Adjust the lateral guides to the width of the document.

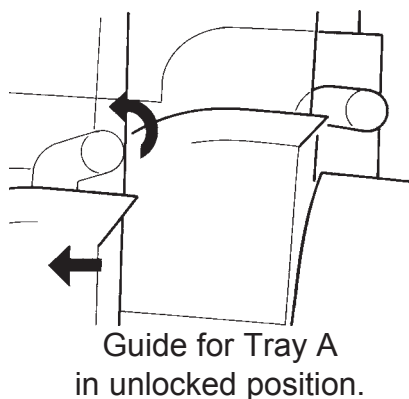
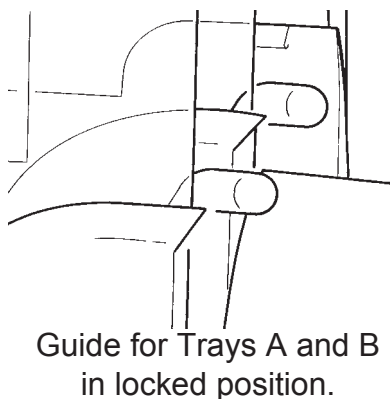

3. Adjust the stack of paper by jogging it on a flat surface. Insert the documents vertically, facing the user. When feeding 2 documents, the sheet containing the address must always be loaded into tray A.

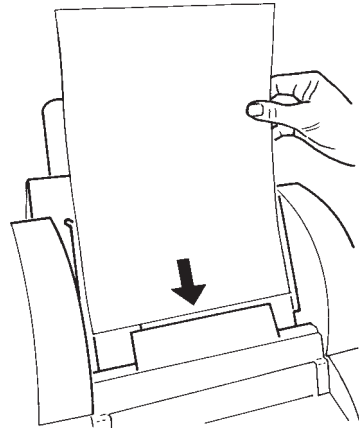

4. Lock the lateral guides and the blue locking levers.



Automatic feeding

- ***Avoid mixing documents of different sizes and weights (thickness) in the same tray.***
- ***In case of documents particularly difficult to handle (uneven, smooth, rough or sticky), use half of the capacity of the feeder.***

Curled documents:

Some laser printers curl the paper excessively. We recommend flattening the printed paper manually before inserting it into the machine.



If the job consists of a single document, tray A and tray B can be loaded : the second tray will start automatically when the first one is empty.

3.2 Loading documents in manual mode (tray A)

Before selecting manual mode, remove any document previously loaded in tray A.

Check and adjust the lateral guides if necessary.

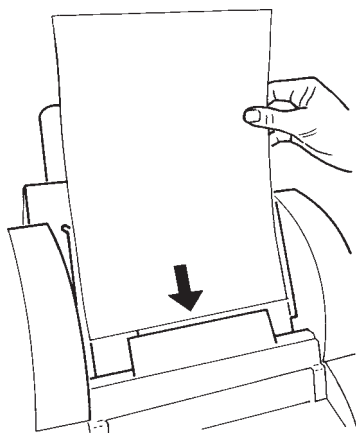

Insert a document or a set of documents manually into tray A to start the cycle.

3.3 Loading envelopes

1. Adjust the rear guide to the size of the envelopes.

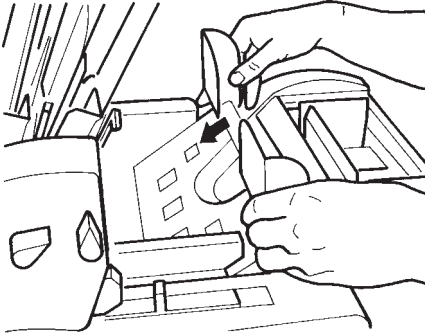

Guide adjusted
for small envelopes

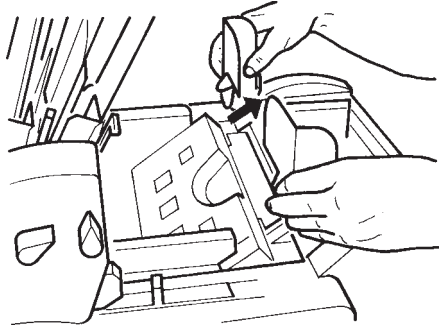

Guide adjusted
for large envelopes

2. Unlock the lever backward to the  position

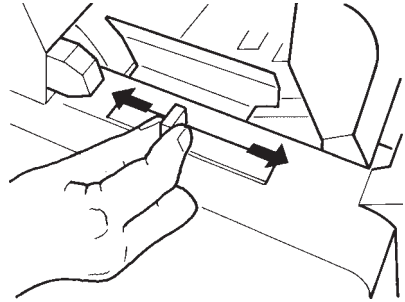

"locked" position : forward

"unlocked" position : backward

3. Adjust the lateral envelope guides

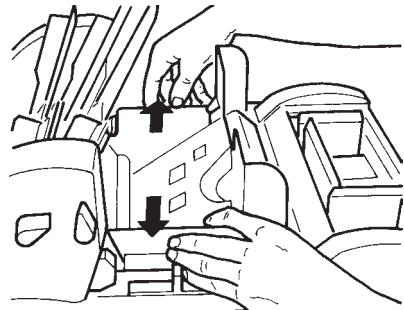

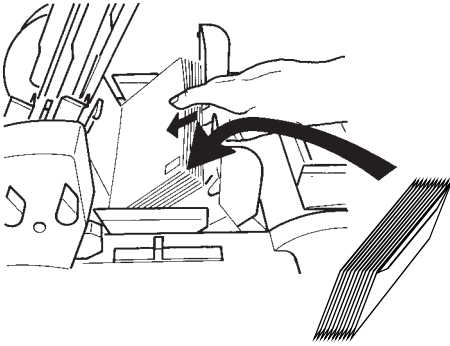

4. Place the envelopes in the envelope tray. The flap should be closed, facing downwards and towards the back of the machine.

5. Adjust the lateral guides to the size of the envelopes, without squeezing them.

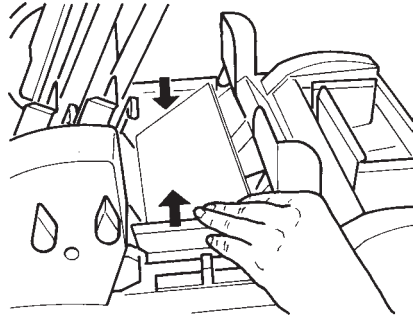

Bottom of the envelope

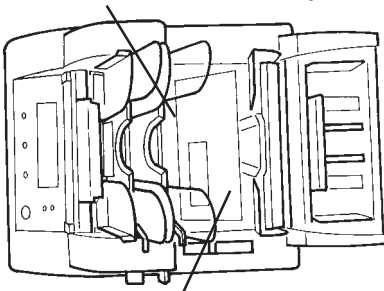

Top of the envelope

6. Lock the lever forward (in position .

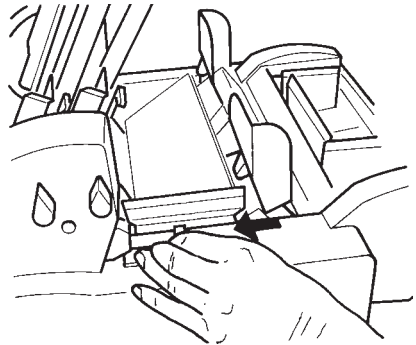

It is not necessary to adjust the guides each time envelopes are loaded, as long as the same type of envelope is being used.

3.4 Loading small inserts and reply envelopes (tray C)

1. Slide the lateral envelope guides apart.

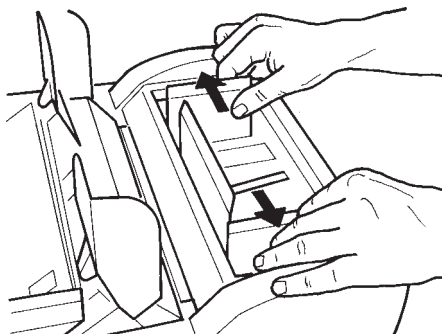

2. Take the stack of small inserts or reply envelopes and jog it on a flat surface.

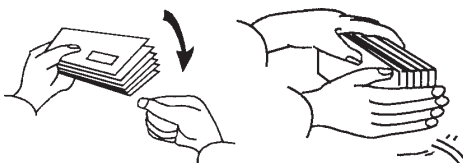

3. Tip the pressure pad backward and holding it there, insert the stack of small inserts or reply envelopes in the tray.

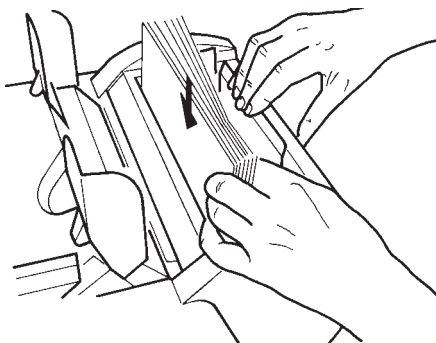

In the case of envelopes, the flap should be closed, facing downwards and towards the back of the machine.

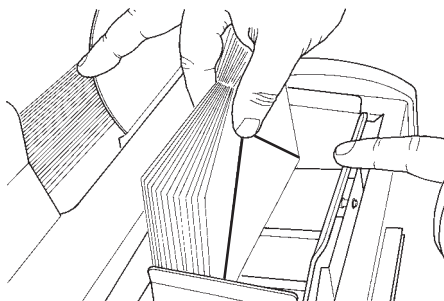

4. Release the pressure pad and bring the guides together against the small inserts or reply envelopes, without squeezing them.

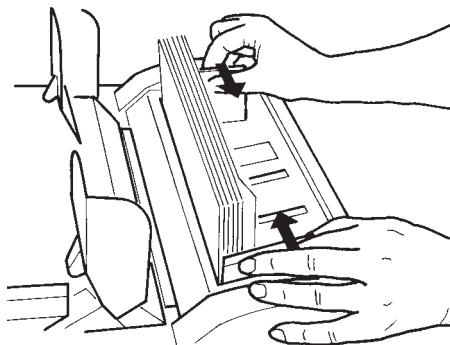







SECTION C: HELP AND ADVICE

1.	HELP GUIDE	47
1.1	Error messages	47
1.2	Symptoms and remedies	53
2.	JAM CLEARING	58
2.1	Clearing the feeders (tray A and B)	58
2.2	Unjamming the document path	59
2.3	Unblocking path of small inserts (tray C)	59
2.4	Clearing the envelope tray	60
3.	CLEANING	61
3.1	Cleaning the rollers	61
3.1.1	Internal rollers	62
3.1.2	Envelope Tray Rollers	63
3.1.3	Tray C Rollers	63
3.1.4	A/B Feeder Rollers	64
3.2	Cleaning/Replacing moistening brushes	65
3.3	Cleaning the covers of the machine	65







1. HELP GUIDE





1.1 Error messages

Screen message	Probable Cause(s)	Remedy
CHECK THE ENVELOPE TRAY	<ul style="list-style-type: none">• No envelope in the holder.• No envelope fed up by the machine.• Envelope distorted.• Envelope crumpled during its progress through the machine.	Reinsert envelopes. Adjust the guides on tray E, check that the envelope path is clear (open the machine if necessary) then press  or  to return to the menu.
CHECK THE DOCUMENT PATH	<ul style="list-style-type: none">• The document or envelope did not go out of the tray;• document is outside the specification or distorted.• Paper overload.	Open the machine, remove paper and envelopes from areas 1 to 8 or open shutter 7 then close the machine to return to the menu.
CHECK THE CONNECTION OF THE PAPER TRAYS	Paper tray connector disconnected (Trays A and B).	Reconnect the connector, open the machine, remove paper and envelopes from areas 1 to 8 and close the machine again. Switch it off, then on again.
CLOSE THE MACHINE	Machine open or not properly closed.	Close the machine in order to continue.

Screen message	Probable Cause(s)	Remedy
<p style="text-align: center;">DOUBLE DOCUMENT DETECTION IN TRAYS A-B</p>	<ul style="list-style-type: none"> • Stuck Documents • Document outside the specification 	<ul style="list-style-type: none"> • Release the blue locking levers, take out the documents. • Separate the documents stuck together. Replace them in the trays, lock the levers and press  or  to return to the menu.
<p style="text-align: center;">DOUBLE DOCUMENT DETECTION IN TRAY C</p>	<ul style="list-style-type: none"> • Stuck Documents • Document outside the specification 	<ul style="list-style-type: none"> • Open the machine and remove the document from the machine. Check its thickness • Take out the stack from Tray C and separate documents stuck together. <p>Press  or  to return to the menu.</p>
<p style="text-align: center;">SWITCH THE MACHINE OFF AND THEN ON AGAIN</p>	<p>A/B Feeder Socket disconnected</p>	<ul style="list-style-type: none"> • Switch off the machine, reconnect the socket and switch on. • Open the machine, remove the documents and envelopes from areas 1 to 8 and close it again.
<p style="text-align: center;">OPEN THE MACHINE AND CLOSE IT AGAIN</p>	<p>The machine was unable to run through its normal cycle.</p>	<ul style="list-style-type: none"> • Open the machine, remove the documents and envelopes from areas 1 to 8 and close it again.

Screen message	Probable Cause(s)	Remedy
KEYBOARD FAULT	When powered up, one or more keys on the keyboard are depressed.	Check if one key is not stuck.
CHECK THE REAR GUIDE OF THE ENVELOPE TRAY	Envelope size does not match the position of the rear guide. Double envelope detected.	<ul style="list-style-type: none"> • Adjust the rear guide of the envelope tray (tray E) according to the size of the envelopes • Open the machine and check that the envelope path is clear.
CHECK THE ENVELOPE PATH	Envelope jammed in the machine.	Open the machine and check the envelope path.
CHECK THE WATER TANK	This message is only a reminder.	Open the machine, check the water level and fill up the tank if necessary. (See Chapter "Filling the moistening tray")

Screen message	Probable Cause(s)	Remedy
<p>REMOVE THE DOCUMENTS FROM THE ENTRY OF TRAYS A + B</p>	<p>Document(s) jammed in the entry of the feeder A (and/or B) stopping the cycle.</p>	<p>Open the entry of the tray, using the lever, remove the jammed document and return the lever to its locked position then press  or  to return to the menu.</p>
<p>NO DOCUMENT IN THE TRAY(S)</p>	<p>The machine has not detected a document in any tray.</p>	<p>Insert documents in tray(s) A, B or C.</p>
<p>CHECK THAT DOCUMENTS ARE MOVING CORRECTLY OUT OF TRAYS A,B</p>	<p>Document jammed in entry A (and/or B), preventing the cycle from running its course.</p>	<p>Open the entry of the tray, using the lever, remove the jammed document and return the lever to its locked position then press  or  to return to the menu.</p>
<p>REMOVE DOCUMENTS FROM TRAY A</p>	<p>The documents in tray A do not match the job selected.</p>	<p>Open the entry to tray A using the lever. Remove the documents and return the lever to its locked position then press  or  to return to the menu.</p>

Screen message	Probable Cause(s)	Remedy
DOUBLE DETECTION, CHECK CONTENTS OF ENVELOPE	Stuck Documents Document outside the specification or detector failure.	.Ensure the remaining documents are not stuck. . Check the contents of the envelope. If the envelope does not contain a double document, remove the documents from the trays, jog them and put them back in the trays or switch off the double detection, then press  or  to return to the menu.
CHECK PAPER PATH OF TRAY C	. Document outside the specification or distorted. . Paper overload.	Apply the clearing procedure described in the chapter "Clearing small insert path (tray C)"
CHECK THAT DOCUMENTS ARE MOVING CORRECTLY OUT OF TRAY C	Document stopped in insert path (entry C), preventing the cycle from completing.	. Check the document position in the tray C. . Apply the clearing procedures described in the chapters "Clearing small insert path (tray C)" and "Clearing document path".
CLOSE TRAY C	. Insert Path is open . Tray C is open or improperly closed.	Close path and tray then press  or  to return to the menu.

Screen message	Probable Cause(s)	Remedy
<p style="text-align: center;">OPEN THEN CLOSE THE MACHINE</p>	<p>The machine was unable to run through its normal cycle.</p>	<p>Open the machine, remove the documents if any are jammed inside and close the machine again.</p>
<p style="text-align: center;">JOB DEFECT Er3</p>	<p>Minor defect, it has become impossible to use this job.</p>	<p>Select another job from the list.</p>

1.2 Symptoms and remedies

Machine jammed	
CAUSES 1. The authorization code was not entered.	REMEDIES 1. Enter the authorization code, see "Installation and Start-up" section.
Envelope not closed or improperly closed	
CAUSES 1. Inadequate moistening 2. Wrong job selection 3. Document/small insert non-compliant or incompatible 4. Job non-compliant with documents used 5. Documents incorrectly inserted	REMEDIES 1. See Remedy insufficient moistening 2. Select "SEAL" in the line "ENVELOPE" 3. Check document compliance with job or check machine specifications 4. Check job content 5. Check settings of lateral guides for documents, small inserts and envelopes . Clean selection and folding rollers if necessary, see chapter "Cleaning the rollers"
The content of the letter is wet	
CAUSES 1. Wrong moistening settings	REMEDIES 1. See section "Advanced Functions", "Setting envelope and special document formats"

2. Exit roller wet	2. Wipe the exit roller, see section "Cleaning the rollers"
Faulty fold	
<p>CAUSES</p> <ol style="list-style-type: none"> 1. Side-guides incorrectly locked or unlocked 2. Dirty rollers 3. Trays A and/or B incorrectly locked 	<p>REMEDIES</p> <ol style="list-style-type: none"> 1. Adjust the document, small insert and envelope guides, see "Loading the document" 2. See the chapter "Cleaning the rollers" 3. Lock the A/B Feeder blue levers
Keyboard fault	
<p>CAUSE</p> <ol style="list-style-type: none"> 1. One or more keys stuck 	<p>REMEDY</p> <ol style="list-style-type: none"> 1. Check to see whether a key is stuck
Rate slowdown and irregular functioning	
<p>CAUSES</p> <ol style="list-style-type: none"> 1. Side-guides too tight against the paper 2. Documents or small inserts wrong size or not straight and flat 3. Dirty rollers 	<p>REMEDIES</p> <ol style="list-style-type: none"> 1. Adjust the document, small insert or envelope side-guides, see "Loading the documents" 2. Check the specifications or, if necessary, adjust/correct the shape of the documents 3. Clean the rollers, see "Cleaning the rollers"

<p>4. Document, small insert or envelope trays overloaded</p> <p>5. Trays incorrectly locked</p>	<p>4. Load fewer documents in the trays- see specification</p> <p>5. Lock the trays</p>
<p>Address incorrectly positioned in the window</p>	
<p>CAUSE</p> <p>1. Fold in wrong place</p>	<p>REMEDY</p> <p>1. Adjust the height of the address in your job.</p>
<p>Shifted ocuments in trays A and B</p>	
<p>CAUSES</p> <p>1. Dirty selection rollers</p> <p>2. Tray A or B lateral guides too tight</p> <p>3. Trays A and/or B incorrectly locked</p>	<p>REMEDIES</p> <p>1. See "Cleaning the rollers"</p> <p>2. Adjust the lateral guides, see "Loading the documents"</p> <p>3. Lock the A/B Feeder blue levers</p>
<p>Double Documents not detected</p>	
<p>CAUSES</p> <p>1. Mixed documents of different types or out of specification documents</p> <p>2. Double detection not activated</p>	<p>REMEDIES</p> <p>1. Process different types of paper separately or see specifications</p> <p>2. Activate Double detection, see "Other advanced functions"</p>

Documents ejected above/below envelope	
<p>CAUSES</p> <ol style="list-style-type: none"> 1. Envelopes incorrectly loaded 2. Envelope out of specification 	<p>REMEDIES</p> <ol style="list-style-type: none"> 1. Correctly position the envelopes in their tray, see "Loading the envelopes" 2. See specification
Insufficient moistening	
<p>CAUSES</p> <ol style="list-style-type: none"> 1. Moistening tray empty 2. Wrong envelope selection, open/closed 3. Dirty moistening brushes 4. Worn moistening brushes 5. Envelope out of specification 6. Poor quality envelope 7. Wrong moistening settings 	<p>REMEDIES</p> <ol style="list-style-type: none"> 1. Fill the moistening tray, see "Installation and Start-up" 2. Select "SEAL" in the line "ENVELOPE" 3. Clean the brushes, see Section "Cleaning" 4. Replace the moistening brushes, see Section "Cleaning" 5. Check the specifications 6. Check quality of seal by sealing the envelope manually 7. See section "Advanced Functions"
Jamming	
<p>CAUSES</p> <ol style="list-style-type: none"> 1. Wrong job selected for application 	<p>REMEDIES</p> <ol style="list-style-type: none"> 1. Select the job corresponding to your documents/application

2. Type or size of fold unsuited to envelope	2. See Specifications
3. Documents or envelopes outside the specifications or distorted	3. See Specifications
4. Dirty rollers	4. See Section "Cleaning the rollers"
5. Lateral guides incorrectly adjusted and/or incorrectly locked	5. See Section "Loading the documents"
6. Too many documents inserted simultaneously	6. See specifications
7. Envelopes incorrectly loaded	7. Position the envelopes correctly in the tray, see section "Loading Envelopes"
8. Small inserts incorrectly loaded	8. Position the small inserts correctly in the tray, see section "Loading the documents"
9. Faulty closure of small insert path	9. Close the small insert path, see section "Unblocking path of small inserts"
10. Unspecified error	10. Switch the machine off; clear the documents and envelopes jammed inside the machine; switch the machine on again.

2. JAM CLEARING

2.1 Clearing the feeders (tray A and B)

- Switch off the machine.
- Tip the feeder forward and unplug the connector.

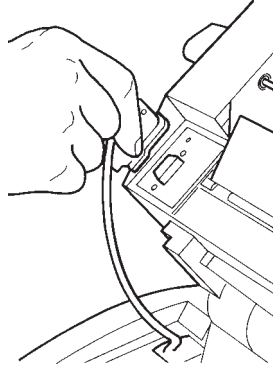

- Take out the feeder from the base.

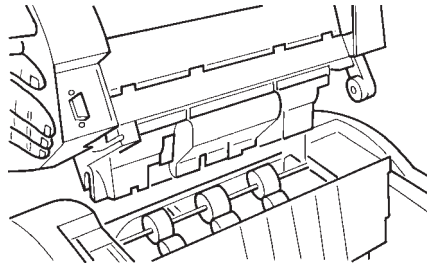

- Remove the jammed document through the lower part of the feeder.
- After unjamming, place the feeder back on the base and plug in the feeder connector.

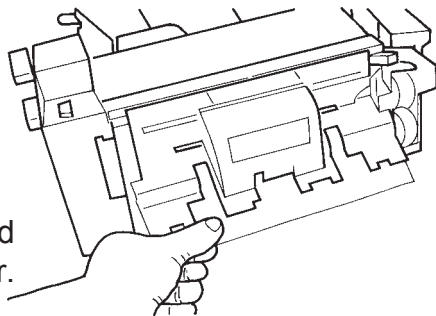

2.2 Unjamming the document path

Open the machine, remove any documents in areas 1 to 8 and behind the shutter 7 (to release the jammed documents, turn blue flywheel D or roller E).

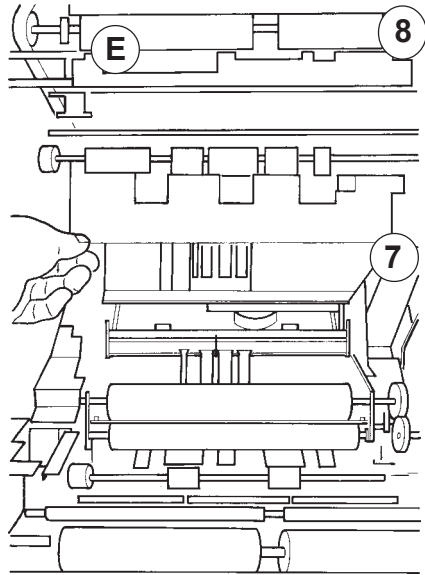

2.3 Unblocking path of small inserts (tray C)

Pinch the opening control located at the back of tray C: it will then tip backward. In the back part of the base, squeeze the two plates

together and raise the assembly. The small inserts path will then become accessible. Remove the jammed small inserts. Close by pressing firmly in the centre until the tray locks into place.

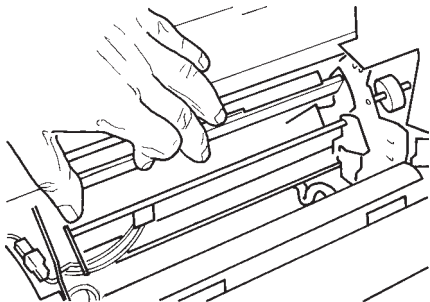
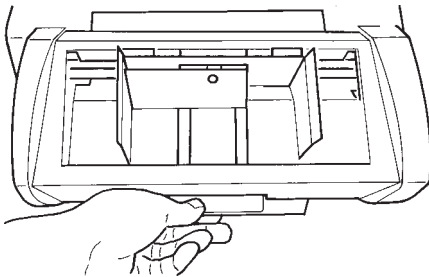

2.4 Clearing the envelope tray

In case of Envelope jamming, perform the following procedure:

- Open the machine, take out the jammed envelope(s) through the internal paper path.
- If some envelopes are still jammed, close the machine, remove the envelope stack and take out the last envelope squeezed by the rollers. For this last envelope, push up the separation plates while pulling the envelope.

3. CLEANING

3.1 Cleaning the rollers

The cleaning of the rollers offers the following benefits:

- Improved paper take-up from the document, small insert and envelope trays,
- Reduced risk of paper jams,
- Preserves the roller material.

To ensure optimal working of the machine, we recommend to clean all rollers at the same time. This operation will take approximately ten minutes (time required for the rollers to dry) It is necessary to remove all the documents from all the trays (including envelopes) before starting.

3.1.1 Internal rollers

- Open the machine
- Use a cleaning product recommended by your reseller and apply it with a lint-free cloth.

Wipe each rubber roller while turning it manually.

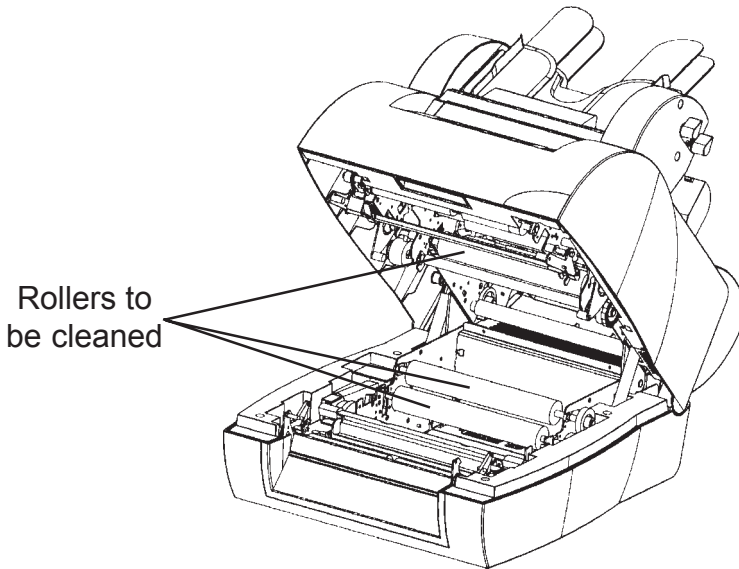

- Close the machine

3.1.2 Envelope Tray Rollers

Use a cleaning product recommended by your re-seller and apply it with a lint-free cloth.

Wipe each rubber roller while turning it manually.

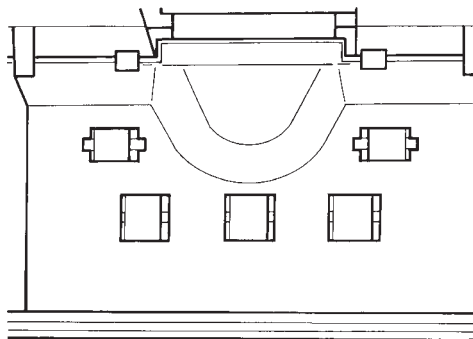

3.1.3 Tray C Rollers

Use a cleaning product recommended by your re-seller and apply it with a lint-free cloth. The rollers identified by a yellow arrow (rear view with tray C lowered) are the ones to be cleaned.

Wipe each rubber roller while turning it manually.

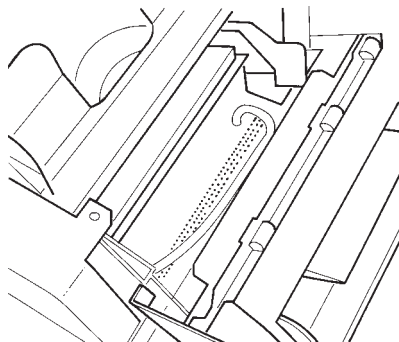

3.1.4 A/B Feeder Rollers

- Power up the machine
- Select feed method "AUTO 1"
- Impregnate 25 mm of the lower part of a 120 g or 80 g sheet of paper with the cleaning product supplied by your seller.
- Place the sheet of paper in the tray, with the strip impregnated with the cleaning product at the bottom.
- While holding the sheet with your hand, press the start key several times, so that the rollers can rub against the sheet. Then release the sheet so it can engage in the machine, pressing the  key.
- If necessary, you can repeat the operation using a new sheet.
- To complete the cleaning process, insert two or three clean, blank sheets in the normal way, before resuming normal document-processing.

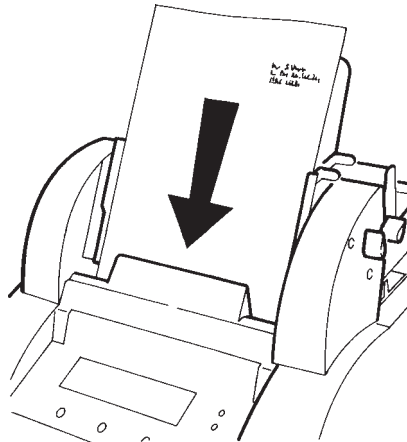

3.2 Cleaning/Replacing moistening brushes

1. Open the machine
2. Remove the moistening tray by holding it with the blue handles.
3. Remove the 3 brushes
4. Clean them with a thin trickle of water
5. If these brushes are worn, replace them with new ones.
6. Put back the brushes in the tray
7. Fill the tray with water and make sure brushes are properly impregnated
8. Insert the moistening tray in its location (with blue handles frontwards)
9. Close the machine

3.3 Cleaning the casing of the machine

Clean with a damp cloth and a slightly soapy solution.

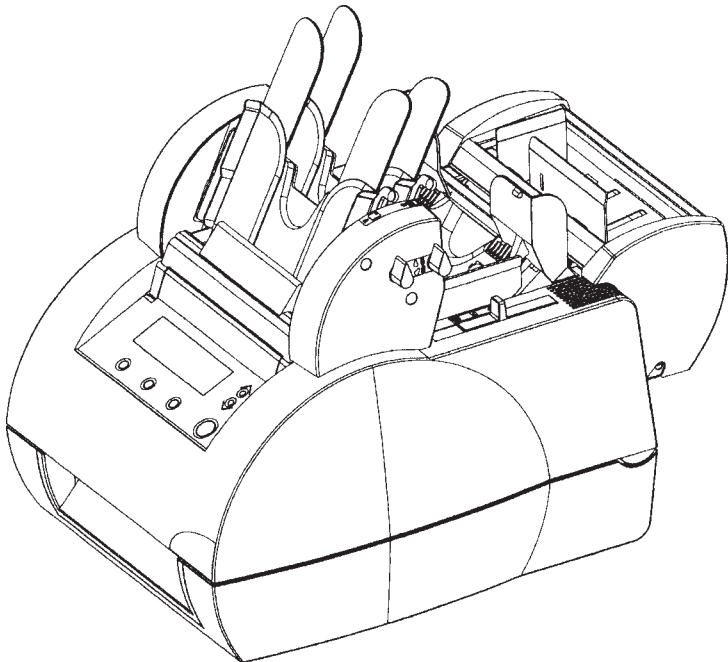

SPECIFICATIONS

Feeder (Trays A and B)

Standard documents

A4 (210x297mm), letter US (8 ½ x 11)

2/3 A4 (210x198 mm), 8 ½ x 8

A4 (210 x 148,5 mm), 8 ½ x 5 ½

Other dimensions

Width	142 to 226 mm
Height	80 to 356 mm
	In 1 mm increments

Paper quality

Coated paper*	90 g/m ² to 120 g/m ²
	In automatic mode
	90 g/m ² to 150 g/m ²
	In manual mode (tray A)

Printed matter, listing paper, photocopies, offset	70 g/m ² to 120 g/m ²
	in automatic and manual mode

Capacity of trays

Standard paper	100 sheets weighing 80g/m ²
----------------	--

In case of documents particularly difficult to handle (uneven, smooth, rough or sticky), use half the capacity of the feeder.

****perform a test.***

Use of this paper requires frequent cleaning of all the rollers.

TRAY B

Size

Width	142 mm to 226 mm
Height	80 to 356 mm

Paper quality

Coated paper*	90 g/m ² to 120 g/m ² In automatic mode
Printed matter, listing paper, photocopies, offset	80 g/m ² to 90 g/m ² in automatic and manual mode

****perform a test.***

Use of this paper requires frequent cleaning of all the rollers.

The insert should always be positioned behind the main document so that it cannot be seen through the window of the envelope.

TRAY C

(enclosed small format documents)

Size

Width	142 mm to 226 mm
Height	80 to 150 mm

Paper quality

Printed matter, listing paper,
Photocopy paper 80 g/m² to 120 g/m²

Offset paper, Bristol board,
*coated paper 80 g/m² to 250 g/m²

*Coated paper
pre-folded 90 g/m² to 170 g/m²

Reply envelope 70 g/m² to 90 g/m²
With or without window

****perform a test.***

Use of this paper requires frequent cleaning of all the rollers.

Capacity of tray 100 reply envelopes
200 inserts of 250 g/m²

ENVELOPE TRAY

Size

Width		224 mm to 240 mm
Height	small	90 mm to 125 mm
	great	152 mm to 165 mm

Folding and insertion capacity

Single fold	Up to 5 sheets	70 to 80 g/m ²
	Up to 3 sheets	86 to 120 g/m ²
Double parallel fold	Up to 3 sheets	70 to 85 g/m ²
	Up to 2 sheets	86 to 120 g/m ²
Insertion without folding	1 small insert	80 to 250 g/m ²
Maximal Insertion Capacity : Up to 5 sheets 70 to 80g/m ²		

4125126F/C - 02/10/2003

